

REED

Model 8906

Thermo-Anemometer

Instruction Manual



www.reedinstruments.com

REED Instruments

1-877-849-2127 | info@reedinstruments.com | www.reedinstruments.com

Table of Contents

Features.....	3
Specifications.....	3
Instrument Description.....	4
Operating Instructions.....	5-10
<i>Single Point Air Velocity (fpm)</i>	5
<i>Continuous Moving Average</i>	5
<i>MIN/MAX/AVG Reading on a Single Point</i>	6
<i>Multipoint Air Velocity Average</i>	6
<i>Auto Power OFF</i>	7
<i>Default unit setting (Imperial or Metric)</i>	8
<i>RS232 Output</i>	9
<i>Measuring fpm, MPH, Knot (km/hour)</i>	9
<i>Direct Single Point Air Flow Measure (cfm)</i>	9
<i>Multipoint Air Flow Average (cfm)</i>	10
<i>MIN/MAX/AVG for Single Point Air Volume</i>	10
Battery Replacement.....	11
Troubleshooting.....	11

Features

- Integral rotary vane sensor for one hand operation
- Simultaneous display of air velocity and temperature
- Continuous moving air velocity averaging of measurements for up to 2 hours
- Displays Min/Max/Avg velocity with temperature values
- Multi-point averaging up to 8 points
- Calculate average velocity values in seconds
- Selectable wind speed units: fpm, m/s, mph, km/h, knots
- Calculate air volume by keying in area dimension
- High-contrast, 4-digit LCD readout
- RS-232 interface
- Data hold and auto power off

Specifications

Air Velocity Range:	80 to 6900 fpm; 0.4 to 35 m/s; 0.9 to 78 mph; 1.4 to 126 km/h; 0.8 to 68 knots
Resolution:	1 fpm; 0.01 m/s, 0.1 mph; 0.1 km/h; 0.1 knot
Accuracy:	±2% f.s.
Temperature Range:	-10 to 50°C (14 to 122°F)
Resolution:	0.1 °C/°F
Accuracy:	±0.6°C (±1.2°F)
Power Supply:	Single 9V battery
Battery Life:	400 hours
Dimensions:	183(L) x 76(W) x 45(D)
Vane Diameter:	70mm (2 7/8")
Includes:	9V Battery, Hard Carrying Case

Instrument Description

1. Power Button
2. Mode Button
3. Hold Button
4. Average Button
5. Unit Button
6. Max. / Min. Button
7. Air Flow Sensor
8. LCD Display
9. Primary Readout: Air velocity/
Air volume/Free area
10. Secondary Readout:
Temperature or Records number

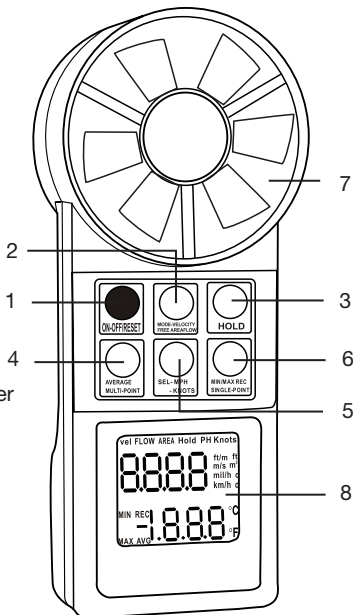

SYMBOL	FUNCTION
vel	Air velocity
FLOW	Air flow/volume
AREA	Free area
Hold	Freezes the reading
ft/m	Feet per minute
ft ²	Square feet
m ²	Square meter
cfm	Cubic feet per minute
cms	Cubic meter per second
°C	Celsius unit
°F	Fahrenheit unit
REC	Record and saved
AVG	Average
MIN	Minimum
MAX	Maximum
-	Negative temperature
Knots	(KN)=1850m/h or 1.15Mil/h
Mil/h	Miles per hours (Imperial)
Km/h	Kilometer per hour (metric)

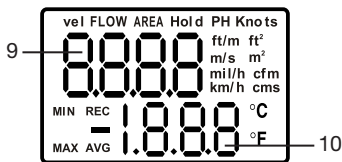

REED Instruments

1-877-849-2127 | info@reedinstruments.com | www.reedinstruments.com

Operating Instructions

For the best results when using your instrument, make sure the airstream and the sensor are aligned as shown (± 20 degrees maximum) and wait 3 seconds for the reading to stabilize.

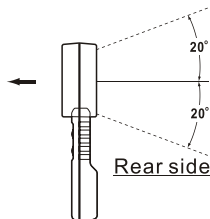

Single Point Air Velocity (fpm)

1. Press the Power button to turn the meter on. The meter will show the full display for the initial 5 seconds.
2. The instrument is ready for use when the LCD display shows "vel" in the upper left corner and temperature in the lower right corner.

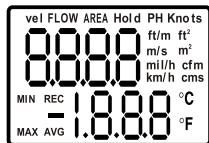

Continuous Moving Average

The meter has the ability to display continuous moving average for up to two (2) hours.

1. Turn the power ON.
2. Place the sensor in front of the air flow source.
3. Press the Max. / Min. button. An "AVG" and "REC" will appear in the lower left corner of the display to confirm the meter is in continuous moving average measurement mode. The display will update every few seconds.

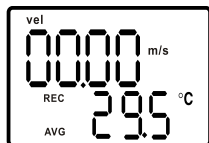

MIN/MAX/AVG Reading on a Single Point

1. Turn the power ON.
2. Place the sensor in front of the air flow source.
3. Press the Max. / Min. button. The unit will begin to record the readings. The meter displays the average velocity by default. Each press of the Max. / Min. button cycles the display through:
 - Real-time readings
 - MIN velocity
 - MAX velocity
 - AVG velocity
4. To revert to normal measurement mode or clear the current MIN, MAX and AVG readings, turn OFF the meter, then turn it ON again or press and hold the Max. / Min. button until the meter beeps twice, then release.
5. Note: Feet Per Minute (fpm) readings can be converted to Cubic Feet per Minute (cfm) readings by following the instructions below:
 - Press the Hold button to store the readings before moving the meter away from an airflow source
 - Press the Mode button to enter area setting. After setting the area, press the Mode button again to convert fpm into cfm.

Multipoint Air Velocity Average

1. Turn the meter ON and position the vane at the first point to be measured. As soon as the first measurement is completed press the Hold button, (you will hear a single beep), and release. The display will show Hold above the reading.

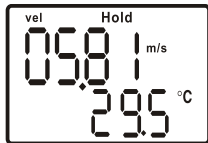

continued ...

REED Instruments

1-877-849-2127 | info@reedinstruments.com | www.reedinstruments.com

2. Press the Max. / Min. button, (you will hear a single beep), and release, (the display will show a digit 1-8). This number represents the point number which has been recorded.
3. Repeat the above procedure until all desired points have been measured and recorded. A maximum of 8 points may be recorded at one time.
4. Once all the measurements have been recorded, press the Average button to view the average air velocity reading and the number of points which are recorded.
5. Press the Hold button to revert to normal measurement mode.
6. To clear multi-point average memory, press and hold the Average button until the unit beeps twice, then release.

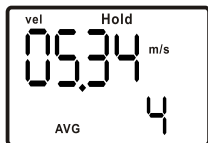
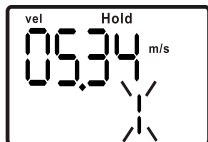

Auto Power OFF

The unit will turn off automatically after 20 minutes to save the battery. This will be preceded by 3 beeps.

To disable auto power off:

1. Turn the power OFF.
2. Press the power button and the Hold button at the same time and then release the Power button only. When an "n" appears on the LCD, you can release the Hold button. The instrument will remain on until the Power button is pressed.

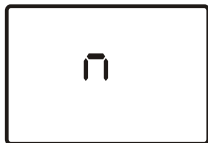

Default unit setting (Imperial or Metric)

The default measuring units can be changed by following the steps below. The unit should be turned off before starting.

1. Press and hold the Average button, then press the Power button once to turn the unit ON. When the LCD displays "ft/m", "m/s", "°C" and "°F", release the Average button.

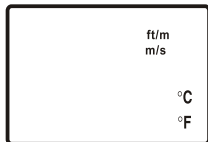

2. To choose the metric units, press the Hold button. The LCD should display "m/s" and "°C". To choose the imperial units, press the Average button. The LCD should display "ft/m" and "°F".

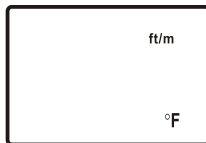
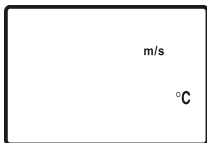

3. Press the Max. / Min. button. The LCD should display "S". Then press the Hold button. The LCD will display 2400 or 1200 (pre-setting).

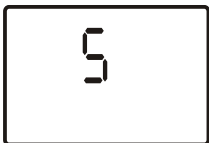

4. Press the Max. / Min. button again, the LCD should display "S" again. Then press the Hold button, the LCD will revert to a normal measurement display. The default setting is now completed.

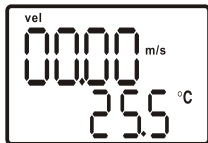

RS232 Output

1. Following Step 3 of *Default unit setting*, you will see a "2400" (default) number on the screen. The 2400 is the default setting of Baud Rate for RS232 output. You can change the setting to "1200" by pressing the Hold button and to "2400" by pressing the Average button.
2. Please remember to save your changes by pressing the Max. / Min. button. An "S" will display on the LCD. Press the Hold button to confirm and save the changed value. The meter will return to air velocity mode automatically.
3. Plug the earphone jack of the cable VZRS232M into the RS232 socket on the meter and connect the 9-pin D-sub to the computer's COM1 or COM2. Press ON to start measurement.



Measuring ft/m, MPH, Knot (km/hour)

In imperial, press SEL.:MPH. KNOT, the reading will change from ft/m, mil/h, knot in turns.

In metric, press SEL.:MPH. KNOT, the reading will change from m/s , km/h, knot in turns.

Direct Single Point Air Flow Measure (cfm)

Air Velocity measurement is calculated by multiplying the air velocity readings by the free area dimensions. You must first determine the free area of the air source before entering it into the meter.

1. Turn the power ON.
2. Press the Mode button once. The LCD will display "AREA" and "1.111" will appear. The first digit will flash.
3. Press the Hold button to increase the number.

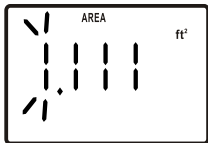

continued ...

REED Instruments

1-877-849-2127 | info@reedinstruments.com | www.reedinstruments.com

4. Press the Average button to advance to next number. Follow Step 3 and repeat to input the free area size.
5. Press the Mode button once all digits have been entered. The word "FLOW" will appear. The meter is now ready to measure air flow (cfm).

Multipoint Air Flow Average (cfm)

1. Follow Step 1 to 4 of *Multipoint Air Velocity Average*.
2. Press the Mode button once and confirm the correct free area setting is locked into the instrument. (If the free area setting must be adjusted, make the necessary changes now.)
3. If the free area setting is correct, press the Mode button again to enter air flow mode.
4. Unit will now display the average air flow reading and the number of points measured.

MIN/MAX/AVG for Single Point Air Volume

1. Turn the power ON, select the mode as FLOW and the place the sensor in front of the air flow source.
2. Press the Max. / Min. button, the unit will begin to record the reading. Press the Max. / Min. button to read the real time value, the MIN, the MAX and the AVG in turns. Long press the Max. / Min. button to clear the average readings.

Battery Replacement

If the LCD display is flashing or there is no display, replacement of the battery is needed.

1. Remove the screw from the lower back of the meter, open the battery cover and remove the battery.
2. Replace with a 9V battery and reinstall the cover.

Troubleshooting

Error E6

If the instruments' display shows *E6*, it indicates the related circuits or parts of the thermistor have failed. Send them back to the store where you bought the instrument for repair.

Sensor's fan will not turn

This indicates the sensor fan is damaged, purchase a new sensor probe.

For service on this or any other REED product or information on other REED products, contact REED Instruments at info@reedinstruments.com

REED Instruments

1-877-849-2127 | info@reedinstruments.com | www.reedinstruments.com

