

# Installation

## S19-110

### Freestanding Drench Shower

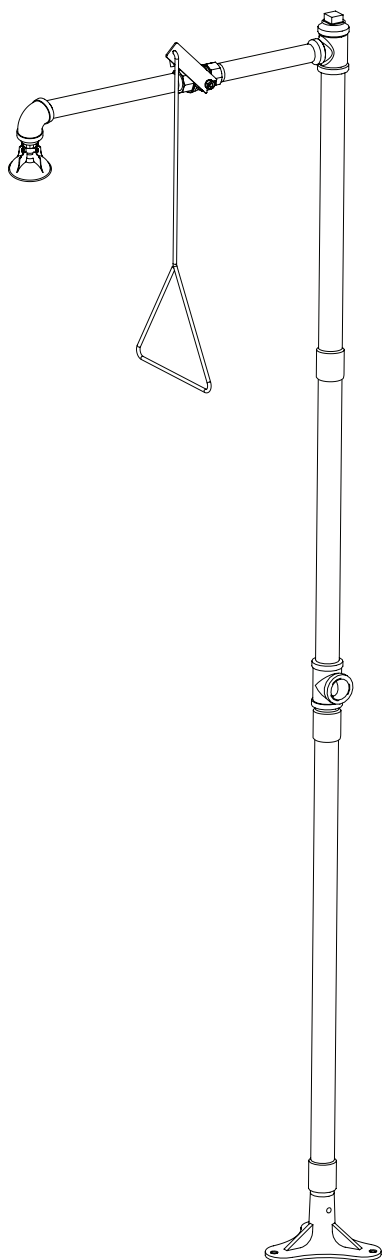

#### Table of Contents

Pre-Installation Information .....	2
Installation Instructions .....	3
Assembly of Components .....	4
Parts List .....	5

 **IMPORTANT** 

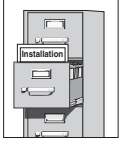

Read this installation manual completely to ensure proper installation, then file it with the owner or maintenance department. Compliance and conformity to drain requirements and other local codes and ordinances is the responsibility of the installer.



Separate parts from packaging and make sure all parts are accounted for before discarding any packaging material. If any parts are missing, do not begin installation until you obtain the missing parts.

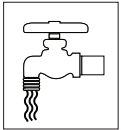

Flush the water supply lines before beginning installation and after installation is complete. Test the unit for leaks and adequate water flow. Main water supply to the eyewash should be "ON" at all times. Provisions shall be made to prevent unauthorized shutoff.

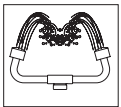

The ANSI Z358.1 standard requires an uninterrupted supply of flushing fluid at a minimum 30 PSI (0.21 MPa) flowing pressure. Flushing fluid should be tepid per ANSI Z358.1.

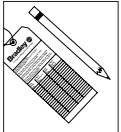

The inspection and testing results of this equipment should be recorded weekly to verify proper operation. This equipment should be inspected annually to ensure compliance with ANSI Z358.1.



Workers who may come in contact with potentially hazardous materials should be trained regarding the placement and proper operation of emergency equipment per ANSI Z358.1.



For questions regarding the operation or installation of this product, visit [www.bradleycorp.com](http://www.bradleycorp.com) or call 1-800-BRADLEY.

Product warranties and parts information may also be found under "Products" on our web site at [www.bradleycorp.com](http://www.bradleycorp.com).

## Installation

### Supplies Required:

- (3) 3/8" floor anchors and bolts
- Teflon tape and pipe sealant
- Piping to 1-1/4" NPT water supply inlet on unit
- Adequate supply pipe supports
- Min. 4" drain to accommodate 30 gallons per minute discharge for shower waste
- OPTIONAL: sign-mounting hardware

*NOTE: Local codes may require the installation of a backflow prevention valve to complete proper installation. Compliance with local codes is the responsibility of the installer. Valve must be tested annually to verify that it is functioning properly. Backflow prevention valves are not included with the fixture and may be supplied by the contractor or purchased from Bradley Corporation.*

### Step 1: Secure base to floor

1. Install three suitable anchors (supplied by installer) for 3/8" bolts in the floor.
2. Bolt the base to the floor anchors using 3/8" bolts (supplied by installer).

### Step 2: Assemble components

1. Assemble the remaining unit components as shown on page 4.
  - Apply pipe sealant (by installer) to all male-threaded pipe joints.
  - Use the rubber grip pad provided or a strap wrench around pipes when tightening to prevent marring the Bradtect® protective, safety yellow coating. Place the grip pad on the pipe, then put the wrench over the grip pad and turn the pipe with the wrench.
  - Bottom edge of showerhead should be 7'-1" (2159mm) from floor.

### Step 3: Connect water supply

#### **IMPORTANT: Do not rely on Bradley's Combination Unit to support supply piping.**

1. Connect water supply piping to 1-1/4" NPT inlet on unit (piping by installer). Provide adequate supports (by installer) for supply pipe using pipe hangers or other means.
2. Hang the safety sign from the unit with the curtain hooks provided (or mount it to the wall using sign-mounting hardware by installer).
3. Open water supply lines. Test for leaks and adequate water flow.

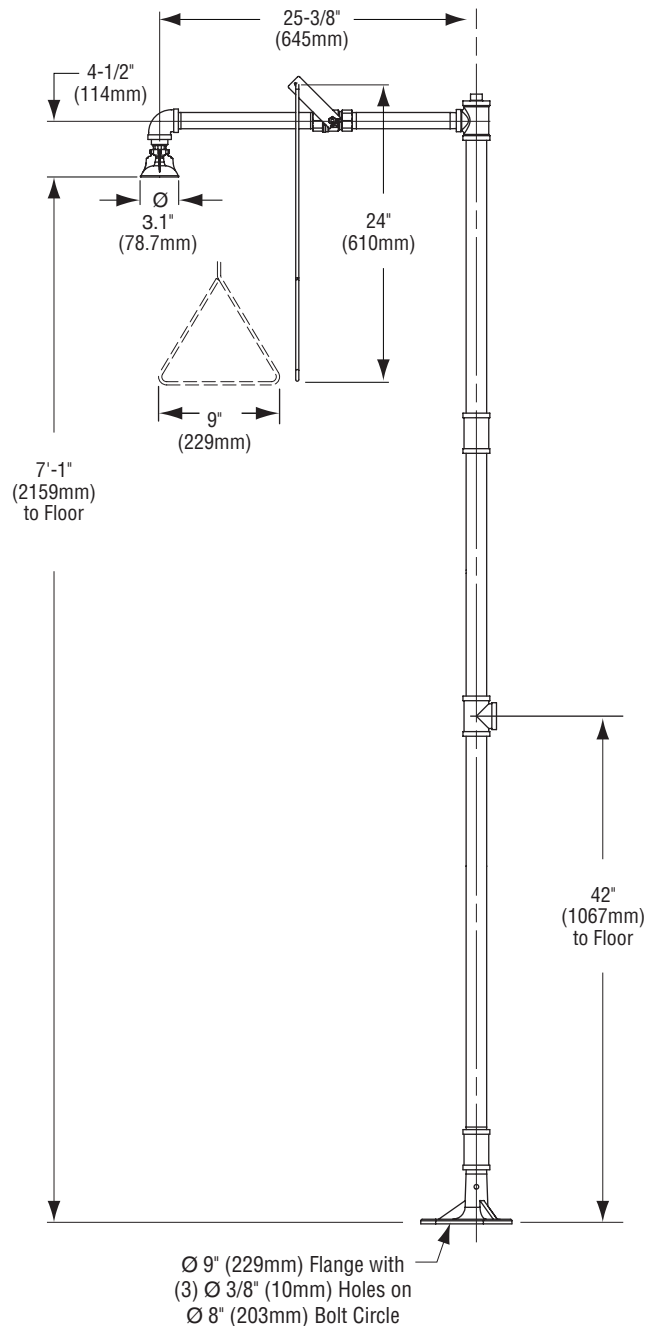

**NOTE: All dimensions assume standard thread engagement. Variations in manufacturing allow for +/- 1/8" (3mm) per threaded joint. To find the tolerance of a dimension, add the number of thread joints in between a dimension and multiply it by 1/8" (3mm).**

# Assembly of Components

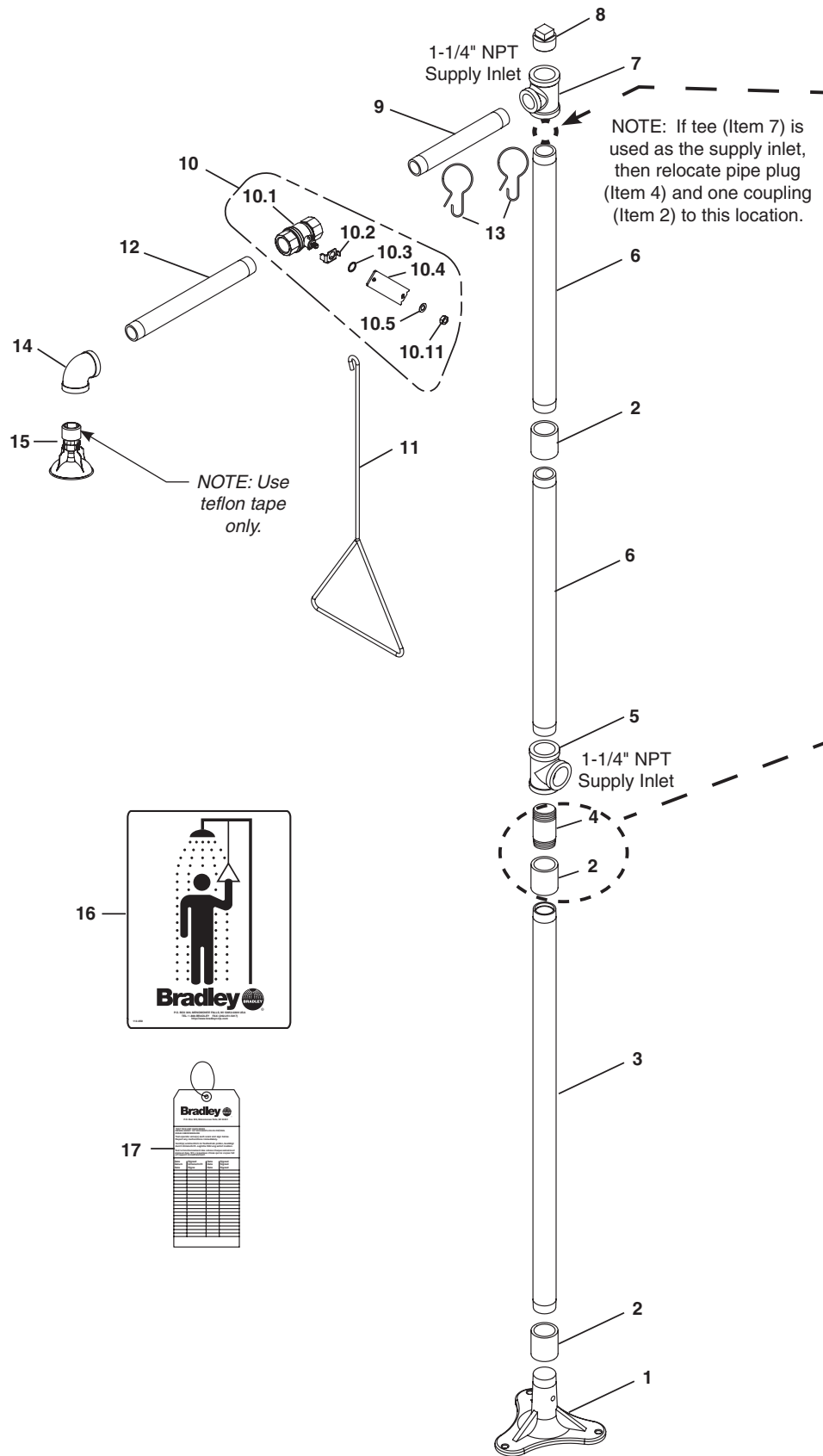

## Parts List

Item	Part No.	Qty	Description	Item	Part No.	Qty	Description
1	131-059	1	Base	10.3	124-048	1	Friction Washer
2	169-853	3	Coupling 1-1/4"	10.4	128-129	1	Handle
3	113-1181	1	Pipe 1-1/4" NPT x 31"	10.5	142-002DC	1	Lockwasher
4	S06-136	1	Pipe Plug	11	128-156A	1	Pull Rod 24" Long
5	169-727	1	Pipe Tee 1-1/4" NPT	12	113-006LK	1	Pipe 1" NPT x 12"
6	113-006LW	2	Pipe 1-1/4" NPT x 22-1/2"	13	151-001	2	Curtain Hook
7	169-722	1	Reducing Tee 1-1/4" x 1-1/4" x 1" NPT	14	169-847	1	90° Elbow 1" NPT
8	169-724	1	Sq. Head Pipe Plug 1-1/4" NPT	15	S24-188	1	Plastic Showerhead Assembly
9	113-006LL	1	Pipe 1" NPT x 9"	16	114-050	1	Safety Sign
10	S30-059	1	Stay-Open 1" Ball Valve Assembly	17	204-421	1	Emergency Inspection Tag
10.1	S27-278	1	Ball Valve 1" with Jam Nut	18	269-915	1	Grip Pad (not shown)
10.11	110-214	1	Jam Nut only				
10.2	140-720	1	Stop Bracket				